



DOZER LIGHTING

For Models : All Large Mining Class Dozers



LED | LIGHTING CATALOG



ENGINEERED LIGHTING SOLUTIONS

Vision X lighting fixtures are not merely lighting systems, they are engineered lighting solutions. They provide increased efficiency, increased safety, decreased environmental impact, and decreased costs. Vision X LED lights offer a large increase in energy efficiency over older technologies while also increasing the safety and productivity of the working environment by outputting 80% more light than the fixtures used previously.

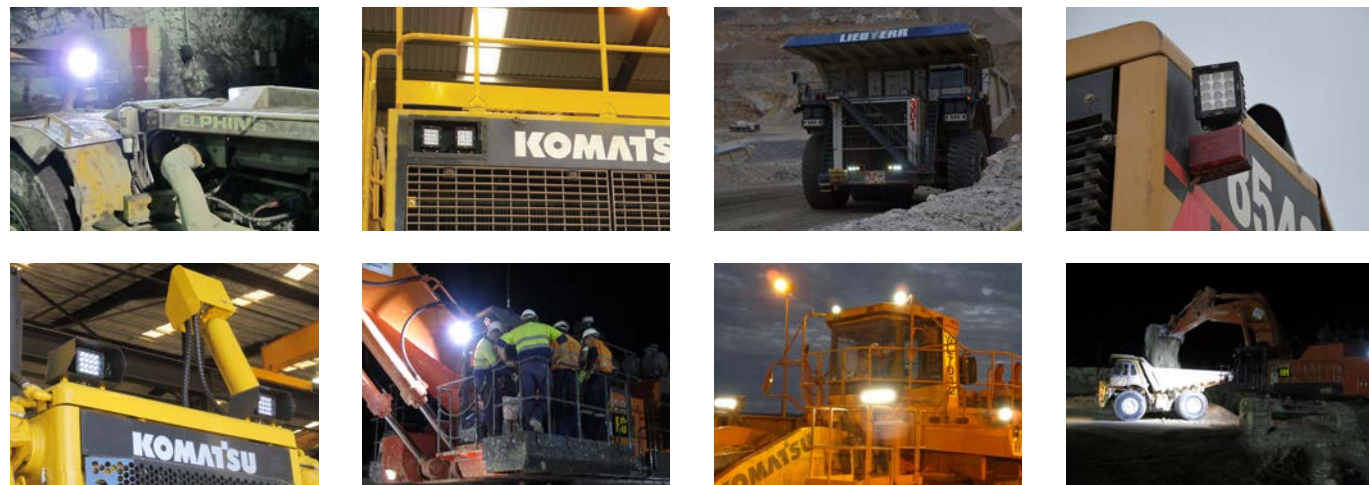

SOLUTION PROCESS



2D BLUEPRINT

Vision X Lighting begins each project with a customer provided list of machines to be retrofitted, then gathers the technical information for those machines.

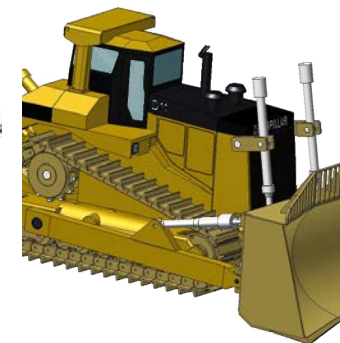

3D MODEL

A 3D model is built to the customer's specifications, then carried over into the rendering.

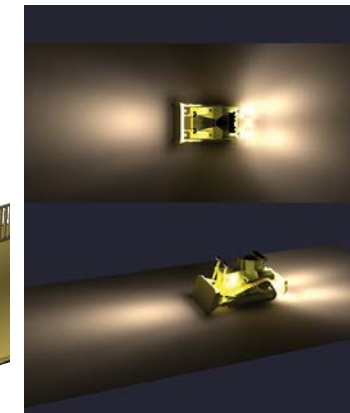

SIMULATION RENDER

A simulation rendering ensures the final product will meet the customer's lighting requirements.

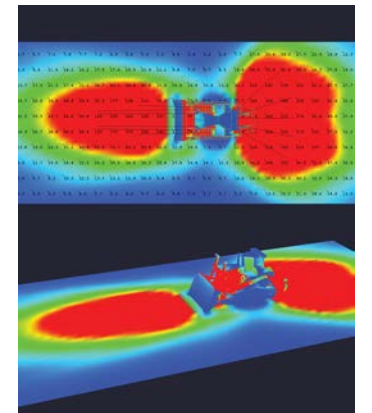

SOLUTION

Vision X Lighting creates a complete breakdown of the customer's specific needs to meet their safety requirements.



DOZER LIGHTING FITOUT GUIDE



1 BT-9 ELLIPTICAL



TRAMMING LIGHTING BT-SERIES WORK LIGHT

Number of Fixtures : 2
Location : **Lift Cylinder**
Beam Pattern : 30/60° Elliptical
Part # : BHB07093065

2 BT-9 FLOOD



WORK AREA LIGHTING BT-SERIES WORK LIGHT

Number of Fixtures : 8
Location : **Lift Cylinder, Top of Cab,
Base of Cab, Rear Bumper**
Beam Pattern : 60° Flood
Part # : BHB070960

3 ID BOARD



ACCESSORY LIGHTING 2&3 DIGIT LED ID BOARDS

Number of Fixtures : 1
Location : **Rear Bumper**
Colors Available : **Green, Red,
Amber in 2&3 Digits**
Part # : MIL-ID02R (Red Shown)

4 HD BEACON



ACCESSORY LIGHTING HEAVY DUTY BEACON

Number of Fixtures : 1
Location : **Top of Cab**
Colors Available : **Green, Red, Blue,
Amber, White**
Part # : MIL-HDBW (White Shown)



TRAMMING / WORK AREA LIGHTING

Product Information

Project Name:
Date:
Type:

Application

OEM replacements will out perform the factory lighting by over 80% on the effective work area. Simple quick connect wiring allows for one time wiring and no further electrical wiring to change the fixture. 3D analysis allows for site specific aiming with our patented aiming system. Industry leading LED light output, size, weight and reliability for reduced unscheduled maintenance.

SPECIFICATIONS

Mechanical Information:

Fixture Weight:	4.98 lbs (2.26kg)
Shipping Weight:	6.05 lbs (18.17kg)
Mounting:	Single Bolt M10

Electric Specifications:

Operating Voltage:	11-65VDC
Wattage:	63W
Operating Temp:	-40°C ~ 85°C
Vibration:	60Grms
Connector:	2 Pin Deutsch

Construction:

Housing:	Die-Cast 6061 Aluminum
Finish:	Gloss Black & Gloss Yellow Bezel
Lens:	Polycarbonate Lens

LED

LED:	XP-L(CREE)
Amp Draw:	5.25A @ 12VDC 2.63A @ 24VDC
Lifespan:	50,000 hr

RATINGS:

EMC Emission:	(CISPR 25) Edition 3.0 (2008-03) Class 3
Ingress Protection:	IP-68, IP69k



PART #:	BEAM PATTERN
1 BHB07093065	Elliptical 30/65°
2 BHB070960	Flood 60°

2D DRAWING:

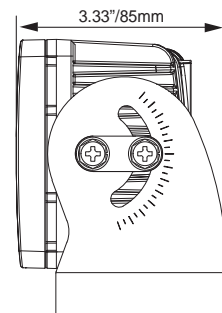
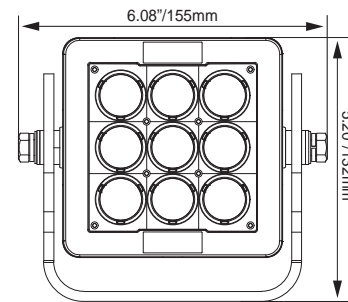



ACCESSORY LIGHTING

Product Information

Project Name:
Date:
Type:

ID Board Sign Information:

- Auto Dim/Bright for Day and Night time Operation
- Available in 2&3 Digit Models
- Red, Yellow, or Green Face Plates

Fixture Weight:	2 lbs (0.9kg)
Wattage	3Digit : 117W 2Digit : 87W
Amp Draw	3Digit : 9.75A@12V 4.88A@24V 2Digit : 6.5A@12V 3.25A@24V
Vibration Rating	15.6 Grms
Application	Vehicle Identification / Load Cap.

2D DRAWING:

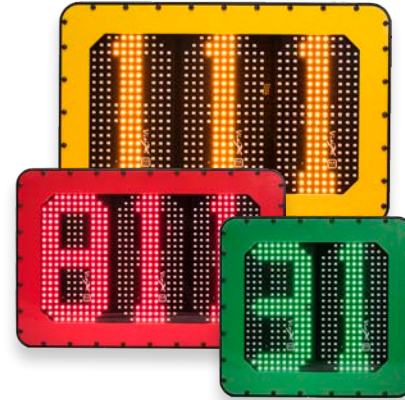
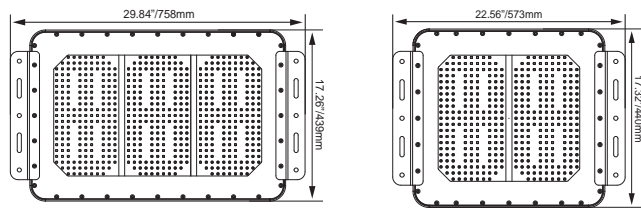

ID BOARD

PART #:	#LEDs / COLOR
3 MIL-ID02A	2 Amber
MIL-ID02R	2 Red
MIL-ID02G	2 Green
MIL-ID03A	3 Amber
MIL-ID03R	3 Red
MIL-ID03G	3 Green

Heavy Duty Beacon Information:

- Simulated Rotation or Flashing Functions
- Available in Amber, Blue, Green, Red, and White LEDs

Fixture Weight:	2.96 lbs (1.34kg)
Wattage	36W
Amp Draw	3.0A @12V 1.5A@24V
Vibration Rating	15.6 Grms
Application	Full 360° Visibility Beacon

2D DRAWING:

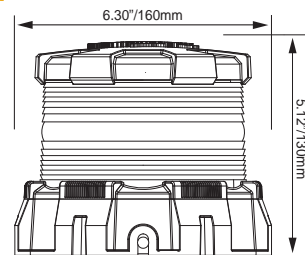

HD BEACON

PART #:	COLOR
4 MIL-HDBA	Amber
MIL-HDBB	Blue
MIL-HDBG	Green
MIL-HDBR	Red
MIL-HDBW	White





VISION X USA
1601 Boundary Blvd
Auburn WA 98001
United States of America
P: 253-218-2900
www.vxindustrial.com



VISION X ASIA
23-7 Dongtansandan
9-gil Dongtan-myeon Hwaseong-si
Gyeonggi-do 18487, Korea
P: 82-32-515-4814
www.visionxasia.com